

NA5 DIGITAL METER WITH BARGRAPH

FEATURES:



INPUT:



OUTPUTS:

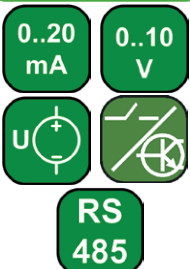

GALVANIC ISOLATION:



Export department:
+48 68 45 75 139/321/386
Fax: +48 68 32 54 091
e-mail: export@lumel.com.pl

LUMEL S.A.
ul. Sulechowska 1
65-022 Zielona Góra
POLAND
WWW.LUMEL.COM.PL



- 3 or 7-colour bargraph with programmable colour switching over,
- Recording of 750 measuring segments, released temporary,
- Universal input,
- Programmable indication characteristic and bargraph magnifier,
- Up to 8 programmable alarm outputs,
- Communication in SCADA systems (RS485/Modbus interface),
- Conversion of measured quantity into an analog standard signal for automation systems.

EXAMPLE OF APPLICATION

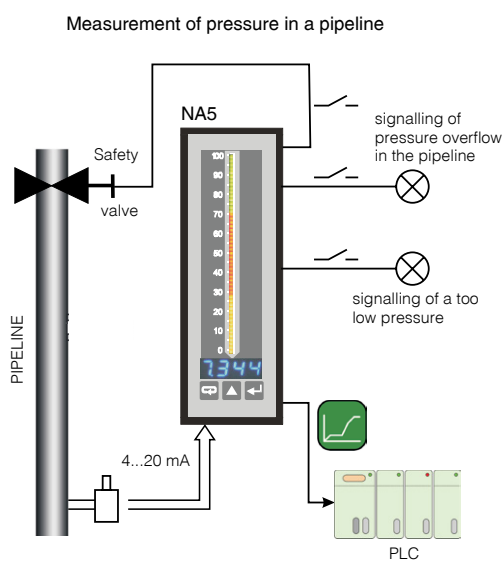

INPUTS

Kind of input	Measuring range	Measurement sub-range
Pt100	-200...850°C	320°C
Pt500	-200...850°C	230°C
Pt1000	-200...850°C	290°C
J (Fe-CuNi)	-100...1100°C	350°C, 700°C
K (NiCr-NiAl)	-100...1370°C	450°C, 950°C
N (NiCrSi-NiSi)	-100...1300°C	550°C, 1000°C
E (NiCr-CuNi)	-100...850°C	250°C, 520°C
R (PtRh13-Pt)	0...1760°C	
S (PtRh10-Pt)	0...1760°C	
T (Cu-CuNi)	-50...400°C	
Resistance	0...10 kΩ	110 Ω, 220 Ω, 460 Ω, 950 Ω, 2100 Ω, 5000 Ω,
Voltage	± 300 mV, Rinp. > 9 MΩ ± 0...600 V, Rinp. > 4.2 MΩ	19 mV, 35 mV, 75 mV, 155 mV, 5 V, 11 V, 22 V, 45 V, 90 V, 180 V, 360 V
Current	± 40 mA, Rinp. < 4 Ω ± 5 A, Rinp. = 10 mΩ ± 10%	5 mA, 11 mA, 23 mA, 1.8 A, 3.8 A

Intensity of current flowing through the resistance thermometer: < 400 μA
Resistance of wires connecting the resistance thermometer with the meter: < 20 Ω/1 wire

OUTPUTS

Kind of output	Features
Analog output	• galvanically isolated with resolution 0.025% of range; current programmable 0/4...20 mA, load resistance ≤ 500 Ω or voltage programmable 0...10 V, load resistance ≥ 500 Ω, output response time: 100 ms.
Relay output	• 4 electromagnetic relays; NOC voltageless contacts, maximal load-carrying capacity: - voltage: 250 V a.c., 150 V d.c. - current: 5 A 30 V d.c., 250 V a.c. - resistance load: 1250 VA, 150 W
Open collector (OC) type	• voltageless of OC type with npn transistor, maximal load: 25 mA, range of appended voltages: 5...30 V d.c.
Digital	• interface type: RS-485; transmission protocol: MODBUS ASCII (8N1, 7E1, 7O1), RTU (8N2, 8E1, 8O1, 8N1); baud rate: 2400, 4800, 9600 bit/s
Additional supply output	• 24 V d.c., maximal load 30 mA

EXTERNAL FEATURES

Readout field	4 LED displays	7-segment digits of 7 mm high, measuring range -1999...9999
	bargraph	bargraph of 88 mm length: - 55 segments in three-colour version - 29 segments in seven-colour version Bargraph resolution: programmable Bargraph accuracy: ± 0.5 segment
Weight	< 0.4 kg	
Overall dimensions	48 × 144 × 100 mm	panel cut-out: 44 ^{+0.5} × 137.5 ^{+0.5} mm
Protection grade (acc. to EN 60529)	IP50 from frontal side	IP20 from terminal side

RATED OPERATING CONDITIONS

Supply voltage	95...253 V a.c./d.c., 20...40 V a.c./d.c.	Power consumption < 12 VA
Temperature	ambient: -10...23...55°C	Storage: -25...85°C
Relative humidity	< 95%	Condensation inadmissible

SAFETY AND COMPATIBILITY REQUIREMENTS

Electromagnetic compatibility	noise immunity	acc. to EN 61000-6-2
	noise emissions	acc. to EN 61000-6-4
Pollution grade	2	acc. to EN 61010-1
Installation category	III	
Maximal phase-to-earth operating voltage	input: 600 V	
	supply: 300 V	
	relays: 300 V	
	analog output: 50 V	
	RS-485: 50 V	

TABLE 1. EXECUTION CODE:

NA5 -	X	X	X	X	X	X	X	X	X	XX	X
Bargraph colour:											
three-color (R, G, R+G)		T									
seven-color (R, G, B, R+G, R+B, G+B, R+G+B)		M									
Display colour:											
lack of display*					0						
red					R						
green					G						
blue					B						
Input signal:											
universal input									U		
Analog output signal:											
lack										0	
current programmable 0/4...20 mA										1	
voltage programmable 0...10 V										2	
Digital output signal:											
lack										0	
RS-485 digital output										1	
Additional output:											
lack*											0
4 relays											4
8 outputs of OC type											8
Supply:											
95...253 V a.c./d.c.											1
20...40 V a.c./d.c.											2
Kind of terminals:											
screwed plug-in sockets											0
Version:											
standard											00
custom-made**											XX
Acceptance tests:											
without an extra quality inspection certificate											8
with an extra quality inspection certificate											7
acc. to customer's request**											X

* - in case of meters without displays, one must order an RS-485 digital output
 ** - after agreeing with the manufacturer

Ordering Example:

The code: **NA5 - M G U 1 1 4 1 0 00 8** means:
NA5 - digital meter with bargraph of NA5 type,
M - with a seven-colour bargraph,
G - green display colour,
U - with an universal input signal,
1 - analog programmable output signal,
1 - RS-485 output current signal,
4 - additional digital output signal: 4 relays,
1 - supply voltage: 95...253 V a.c./d.c.,
0 - terminals of plug-in socket type,
00 - standard version,
8 - without extra quality requirements.

CONNECTION DIAGRAMS

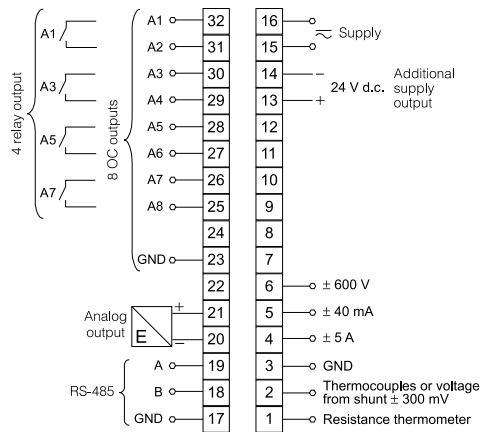
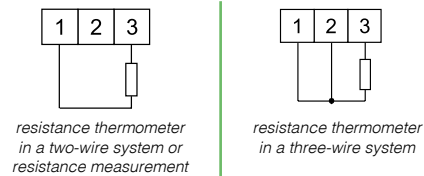
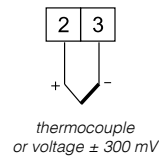

Fig. 1 Description of the terminal strip.



resistance thermometer in a two-wire system or resistance measurement

resistance thermometer in a three-wire system



thermocouple or voltage ± 300 mV

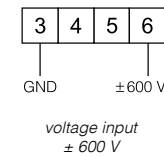

voltage input ± 600 V

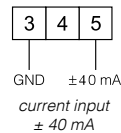

current input ± 40 mA

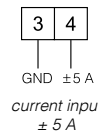

current input ± 5 A

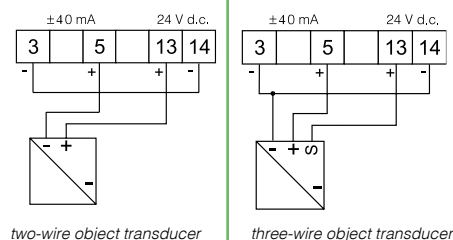

two-wire object transducer

three-wire object transducer

Fig. 2 Connection way of input signals.

SEE ALSO:



Temperature and humidity transducers P18 i P18L types.



Programmable transducer of temperature, resistance, voltage from shunt and standard signals - P20



N30 digital meters with a 3-colour display and free eCon program.

For more information about LUMEL's products please visit our website:
www.lumel.com.pl

Export department:
 +48 68 45 75 139/321/386

Fax: +48 68 32 54 091
e-mail: export@lumel.com.pl

LUMEL S.A.
 ul. Sulechowska 1
 65-022 Zielona Góra
 POLAND
WWW.LUMEL.COM.PL